

# DEVAS

*home lifts*

ÜRÜN KATALOĞU

PRODUCT CATALOGUE



[www.devas.com.tr](http://www.devas.com.tr)

meeting point for more qualified life...

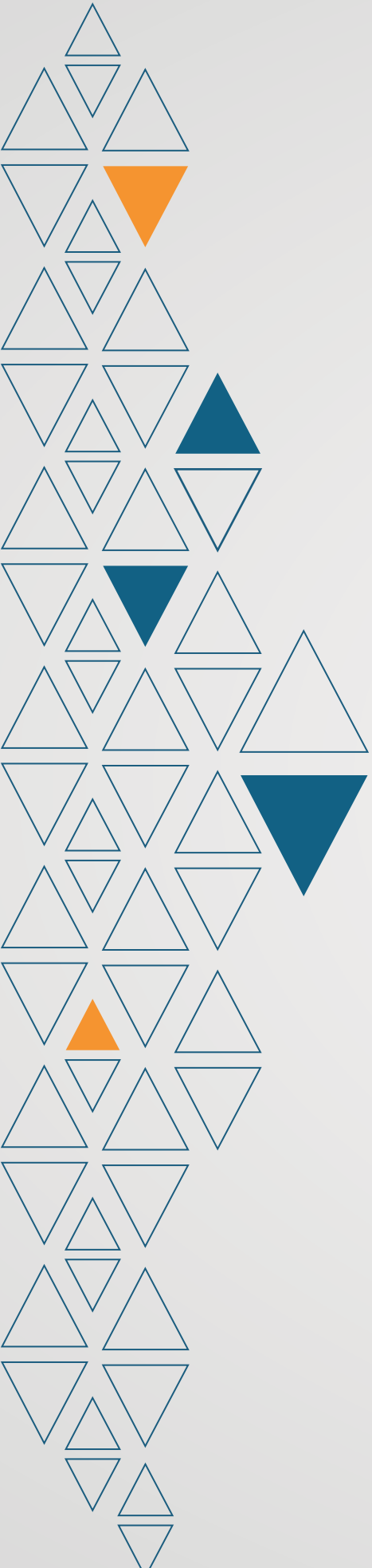

**DEVAS**  
*home lifts*

**daha iyi bir yaşam için  
buluşma noktası...**  
meeting point for more qualified life...



# HAKKIMIZDA

## ABOUT US



### Daha iyi bir yaşam için buluşma noktası...

1996 yılında Kayseri’de kurulan DEVAS Engelli Asansörü Üretim Merkezi, başarılı geçmişi ile toplam 15.900 m<sup>2</sup> alanda dünyanın önde gelen platform ve homelift asansör sistemleri üreticisidir.

Modern üretim tesisleri ve makine parkurumuz ile dünya çapında her türlü mimari yapıya ev ve engelli asansörü üretir, montajını yapar, servis eder ve modernleştirir. Proje Yönetimi ve asansör teknolojileri hakkında bilgi birikimine, uluslararası iş deneyimi ve disiplinine sahiptir. Asansör ile ilgili standartların, teknik şartnamelerin, yasal ve idari mevzuatların gerekliliklerini yerine getirir.

Ev ve engelli asansör sistemleri sektöründe lider olma vizyonuyla hareket eden Devas, gelişen rekabette teknolojiyi kullanan, doğru ürün, doğru marka ve fiyat avantajları ile dünya çapındaki gelişmelere hızla uyum sağlayarak Türkiye’deki değişimin öncüsü olmuştur.



### Meeting point for more qualified life...

As it established in 1996 in Kayseri, DEVAS Disabled Lift Production Center is the world's leading manufacturer on a area of 15.900 m2 of platform and homelift lift systems, with a successful history.

With our modern production facilities and modern machinery, we produce worldwide home and handicapped elevators for all kinds of architectural structures. We assemble, service and modernize.

Having knowledge about Project Management and Elevator technologies, International work experience and discipline, We fulfill the requirements of the relevant standards, technical specifications, legal and administrative regulations.

Devas, acting with the vision of being a leader in the homelift and disabled elevator systems sector, It has become the leader of change in Turkiye by rapidly adapting to global developments with the right product, the right brand and price advantages, using technology in the developing competition.

# Kendi asansörünüzü kendiniz tasarlayın...

Design your own elevator...

İstediğiniz ürünün tasarımını kolaylıkla yapabileceğiniz ve üç boyut inceleyebileceğiniz DEVAS TASARIM ATÖLYESİ hizmetinizde.

DEVAS DESIGN WORKSHOP is at your service, where you can easily design the elevator you want and examine it in three dimensions.



[tasarla.devas.com.tr](https://tasarla.devas.com.tr)



# Asansör Yapılandırıcı

Müşterilerimizin mevcut tüm seçenekleri keşfetmelerini ve ardından istek ve ihtiyaçlarına en uygun tasarımı gerçek zamanlı 3D olarak doğrudan web sitesinde uyarlamalarını sağlar.

Bu sadece müşterilerimizden gelen etkileşimi artırmakla kalmaz, aynı zamanda ürün yelpazemizin ve müşterilerimizin hayallerindeki asansörü tasarlaması için sunduğumuz fırsatların daha iyi anlaşılmasını sağlar.

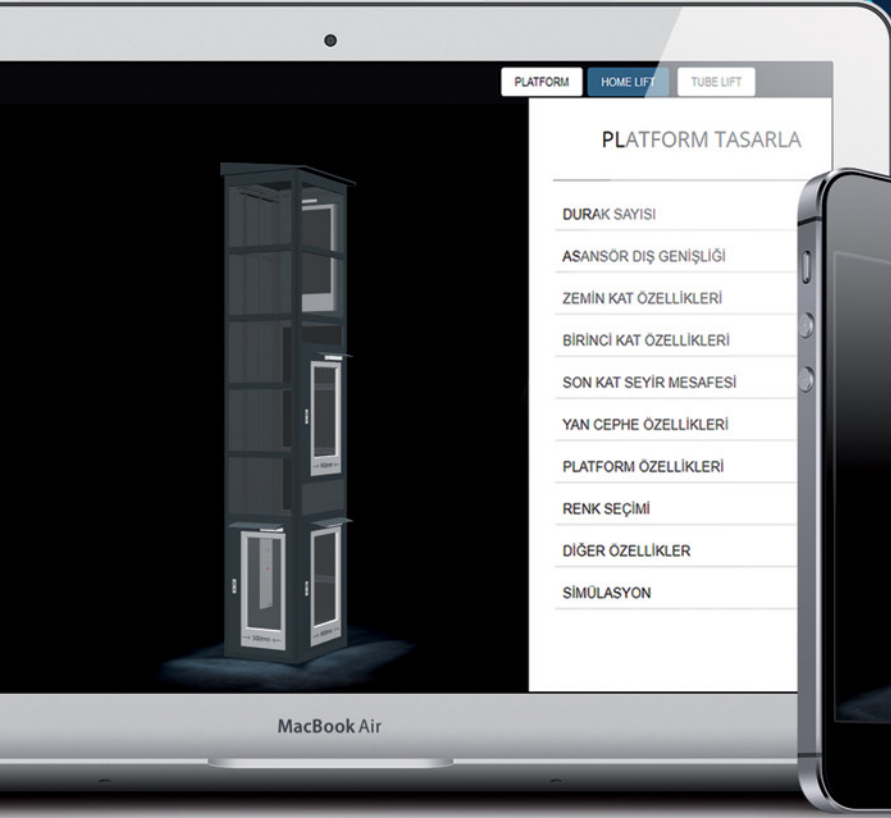
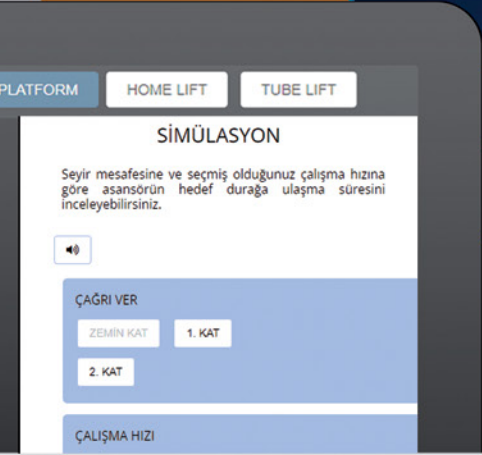

"DEVAS DESIGN" allows our customers to see all the available options and helps them to design the best elevator for their needs. Now you can design it in real-time 3D live on the website.

"DEVAS DESIGN" also increases interaction of our customers, and also provides a better solutions with our various product range.

We have many different opportunities for you to design elevator that you dream.

<https://tasarla.devas.com.tr/>

# KAPALI TİP ENGELLİ PLATFORMU

CLOSED TYPE  
DISABLED PLATFORM

- ▶ HYD-VK
- ▶ HYD-BK

6 metre ve üzeri bir seyir uzunluğu ile çalışan sonsuz vidalı engelli asansörü yelpazesi söz konusu olduğunda

**ÜRÜNLERİMİZ BENZERSİZDİR...**



**Daha iyi bir yaşam için**  
buluşma noktası...  
meeting point  
for a better life...

# HYD-VK

Sonsuz Vida Milli Tahrik  
Screw Nut System



 400 Kg Max. Capacity	 Maksimum Number of stops 5	 No machine room	 Emergency rescue Ups / Battery	 Do not require a pit	 1100x1400 mm (W x D) Platform size	 1600x1600 mm (W x D) Tower dimensions	 Door Size Full Auto 900x2000 mm (WxH)
 0,15m/sn. Max. Speed	 110 / 230 V 50-60 Hz	 Engine 2.2 kW	 Screwed drive type	 30.000 mm Max. Travel	 Soundless	 3 Language Voice Announcements	

Asansör kuyusu ve ruhsat gerektirmeyen, tekerlekli sandalye ile de kullanılabileceğiniz HYD-VK Avrupa standartlarına tam olarak uygun olup Udem Adriatic tarafından onaylanmıştır. İç mekan veya dış mekanlarda güvenle kullanılır. Kullanım kolaylığı, pratik montajı ve asgari inşaat masrafı ile yapılarınız için uygundur. İthal kilit sistemi, geliştirilmiş kovan sistemi, bronzdan imal edilmiş somun, honlanmış özel sonsuz vida ile sessiz ve konforlu olan seyahati düşük bakım maliyeti ile sunar. 6 farklı standart ölçü ile üretildiği gibi istenildiğinde yapılarınızın fiziki durumlarına uygun özel ölçü ve özelliklerde üretilmektedir. Küçük bir ev aleti kadar enerji tüketen ürünlerimiz invertör sürüş sistemi ile yumuşak kalkış ve duruş konforu sunarken, evsel enerji tüketiminizi de düşürür.

Which does not require an elevator pit and does not require a license and can be used with a wheelchair, fully complies with European standards and has been approved by Udem Adriatic. It can be used safely indoors or outdoors. It is suitable for your buildings with its ease of use, practical assembly and minimum construction cost. It offers quiet and comfortable travel with its imported lock system, improved sleeve system, nut made of bronze, honed special endless screw, and has low maintenance costs. It is produced in 6 different standard sizes, as well as in special sizes and features suitable for the physical conditions of your buildings when its requested. Our products, which consume as much energy as a small household appliance, offer soft starting and stopping comfort with the inverter driving system. It also reduces your domestic house energy consumption.



TS EN 81-41

	For Seat Use				For Wheelchair Use	
	VK 1100	VK 1200	VK 1300	VK 1400	VK 1500	VK 1600
<b>SINGLE ENTRY</b>						
Structural Opening	1150x1150 MM	1250x1250 MM	1350x1350 MM	1450x1450 MM	1550x1550 MM	1650x1650 MM
Tower Dimensions	1100x1100 MM	1200x1200 MM	1300x1300 MM	1400x1400 MM	1500x1500 MM	1600x1600 MM
Platform Size	600x900 MM	700x1000 MM	800x1100 MM	900x1200 MM	1000x1300 MM	1100x1400 MM
Door Opening [WxH]	600x2000 MM	700x2000 MM	800x2000 MM	900x2000 MM	900x2000 MM	900x2000 MM
<b>OPPOSING ENTRY</b>						
Structural Opening	1150x1150 MM	1250x1250 MM	1350x1350 MM	1450x1450 MM	1550x1550 MM	1650x1650 MM
Tower Dimensions	1100x1100 MM	1200x1200 MM	1300x1300 MM	1400x1400 MM	1500x1500 MM	1600x1600 MM
Platform Size	600x900 MM	700x1000 MM	800x1100 MM	900x1200 MM	1000x1300 MM	1100x1400 MM
Door Opening [WxH]	400x2000 MM	500x2000 MM	600x2000 MM	700x2000 MM	800x2000 MM	900x2000 MM
<b>DIAGONAL ENTRY</b>						
Structural Opening	1150x1150 MM	1250x1250 MM	1350x1350 MM	1450x1450 MM	1550x1550 MM	1650x1650 MM
Tower Dimensions	1100x1100 MM	1200x1200 MM	1300x1300 MM	1400x1400 MM	1500x1500 MM	1600x1600 MM
Platform Size	600x900 MM	700x1000 MM	800x1100 MM	900x1200 MM	1000x1300 MM	1100x1400 MM
Door Opening [WxH]	400-600x2000 MM	500-700x2000 MM	600-800x2000 MM	700-900x2000 MM	800-900x2000 MM	900x2000 MM
<b>GENERAL DIMENSION</b>						
Load Capacity	180 KG	225 KG	300 KG	375 KG	450 KG	500 KG
Headroom	2350 MM	2350 MM	2350 MM	2350 MM	2350 MM	2350 MM
Pit Height	120 MM	120 MM	120 MM	120 MM	120 MM	120 MM

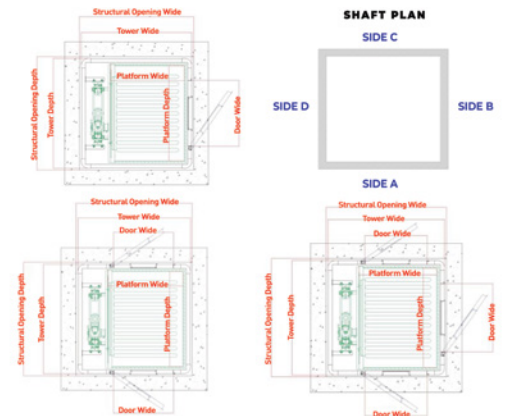
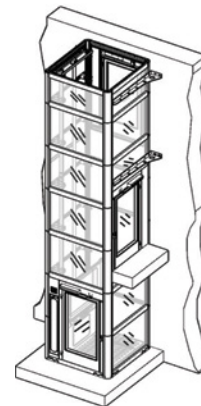

# HYD-BK

Hidrolik Tahrikli Sistem  
Hydraulic System



 <p>500 Kg Max. Capacity</p>	 <p>Maksimum Number of stops 5</p>	 <p>No machine room</p>	 <p>Emergency rescue Ups / Battery</p>	 <p>Do not require a pit</p>	 <p>1100x1400 mm (W x D) Platform size</p>	 <p>1600x1600 mm (W x D) Tower dimensions</p>	 <p>Door Size Full Auto 900x2000 mm (WxH)</p>
 <p>0,15m/sn. Max. Speed</p>	 <p>110 / 230 V 50-60 Hz 1/3 Phase</p>	 <p>Engine 2.9 kW</p>	 <p>Hydraulic drive type</p>	 <p>14.000 mm Max. Travel</p>	 <p>Soundless</p>	 <p>3 Language Voice Announcements</p>	



TS EN 81-41: 2010 Avrupa standartları ve A3 direktiflerine uygun hidrolik tahrik ve semer tip hidrolik engelli asansörleri kuyu dibi, ruhsat ve asansör kuyusu gerektirmez. Halat kopmalarına karşı mekanik fren sistemi, hortum patlatma valfi, debi sınırlama valfi, gevşek halat valfi, küresel vana, el pompası, manüel el ile kurtarma sistemi ve manometre gibi bir çok özellik ile donatılmıştır. Çift hızlı yumuşak kalkış ve duruş özelliğine sahip Alman menşei KV1S valf takımı, hidrolik ünitelerin vazgeçilmez bileşeni ultra sessiz İtalyan menşei Settima vidalı pompalar ve yağın içerisinde dönen SB dalma motor ile dizayn edilir.

Hydraulic drive and saddle type hydraulic disabled lifts in accordance with European standards and A3 directives.

It does not require a pit, license and elevator space. It is equipped with many features such as mechanical brake system against rope breakage, hose burst valve, flow limiting valve, slack rope valve, ball valve, hand pump, manual hand rescue system and manometer.

German origin KV1S valve set with double speed soft start and stop feature, Ultra-quiet Italian origin Settima screw pumps, the indispensable component of hydraulic units, and it is designed with SB submersible motor rotating in oil.



For Seat Use

For Wheelchair Use

	BK 1100	BK 1200	BK 1300	BK 1400	BK 1500	BK 1600
<b>SINGLE ENTRY</b>						
Structural Opening	1150x1150 MM	1250x1250 MM	1350x1350 MM	1450x1450 MM	1550x1550 MM	1650x1650 MM
Tower Dimensions	1100x1100 MM	1200x1200 MM	1300x1300 MM	1400x1400 MM	1500x1500 MM	1600x1600 MM
Platform Size	600x900 MM	700x1000 MM	800x1100 MM	900x1200 MM	1000x1300 MM	1100x1400 MM
Door Opening (WxH)	600x2000 MM	700x2000 MM	800x2000 MM	900x2000 MM	900x2000 MM	900x2000 MM
<b>OPPOSING ENTRY</b>						
Structural Opening	1150x1150 MM	1250x1250 MM	1350x1350 MM	1450x1450 MM	1550x1550 MM	1650x1650 MM
Tower Dimensions	1100x1100 MM	1200x1200 MM	1300x1300 MM	1400x1400 MM	1500x1500 MM	1600x1600 MM
Platform Size	600x900 MM	700x1000 MM	800x1100 MM	900x1200 MM	1000x1300 MM	1100x1400 MM
Door Opening (WxH)	400x2000 MM	500x2000 MM	600x2000 MM	700x2000 MM	800x2000 MM	900x2000 MM
<b>DIAGONAL ENTRY</b>						
Structural Opening	1150x1150 MM	1250x1250 MM	1350x1350 MM	1450x1450 MM	1550x1550 MM	1650x1650 MM
Tower Dimensions	1100x1100 MM	1200x1200 MM	1300x1300 MM	1400x1400 MM	1500x1500 MM	1600x1600 MM
Platform Size	600x900 MM	700x1000 MM	800x1100 MM	900x1200 MM	1000x1300 MM	1100x1400 MM
Door Opening (WxH)	400-600x2000 MM	500-700x2000 MM	600-800x2000 MM	700-900x2000 MM	800-900x2000 MM	900x2000 MM
<b>GENERAL DIMENSION</b>						
Load Capacity	180 KG	225 KG	300 KG	375 KG	450 KG	500 KG
Headroom	2350 MM	2350 MM	2350 MM	2350 MM	2350 MM	2350 MM
Pit Height	120 MM	120 MM	120 MM	120 MM	120 MM	120 MM

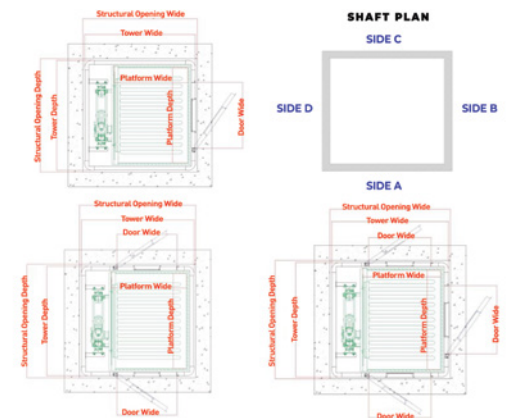
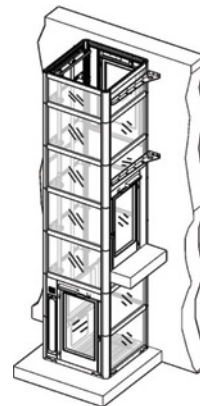



**DEVAS**  
home lifts

**DEVAS**  
home lifts

**DEVAS**

Handwritten notes on a clipboard, including a signature and some illegible text.

# ÜRETEN TÜRKİYE'NİN GÜCÜYÜZ

WE ARE THE POWER  
OF PRODUCING  
TÜRKİYE

1996'dan Beri  
Değişimin Öncüsü...

The Leader of Change Since 1996



# AÇIK TİP ENGELLİ PLATFORMU

OPEN TYPE  
DISABLED PLATFORM

- ▶ HYD-V
- ▶ CORE

GÜVENİLİR MÜHENDİSLİK...

RELIABLE ENGINEERING...



Kapalı yerde kalma  
**korkusuna son...**

End your  
Claustrophobia...

# HYD-V

**Sonsuz Vida Milli Tahrik**  
Screw Nut System



 250 Kg Max. Capacity	 Maksimum Travel 3.000 mm	 No machine room	 Emergency rescue Ups / Battery	 Do not require a pit	 850x1200 mm (W x D) Platform size	 1300x1300 mm (W x D) Tower dimensions	 Door Size Full Auto 900x1100 mm (WxH)
 0,15m/sn. Max. Speed	 110 / 230 V 50-60 Hz 1/3 Phase	 Engine 0.75 kW	 Screwed/Hydraulic Drive Type	 +50° / -35°	 Optional bellows	 3 Language Voice Announcements	



Kapalı yerde kalma korkunuz günlük yaşamınızı etkiliyor mu? Bütçenize uygun, yer avantajı sağlayan, konforlu ve güvenli olduğu kadar görünüşüyle dikkat çeken HYD-V, kısa mesafeler için avantajlı çözümdür. Paslanmaz çelik kaplaması, estetik dizaynı ve duruşlarda optimum konforu ile kullanıcılarının yaşam kalitesini artırır. Otomatik açılıp kapanan krom kapı ve platform altı körük sistemi sizlere her zaman güvenilir seyahat sunar.

Does staying indoors affect you horrible daily life? The HYD-V is an attractive solution for short distances as it is as comfortable and safe as it is affordable for your budget. Stainless steel coating aesthetic design and optimum comfort during stoppages to enhance the quality of life of the users. Automatic opening and closing of the chrome doors and under-platform bellows system provides you with reliable travel all the time.

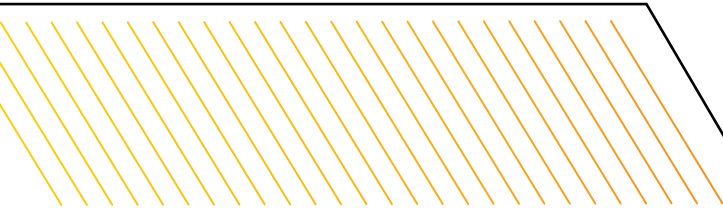

CE  
TS EN 81-41

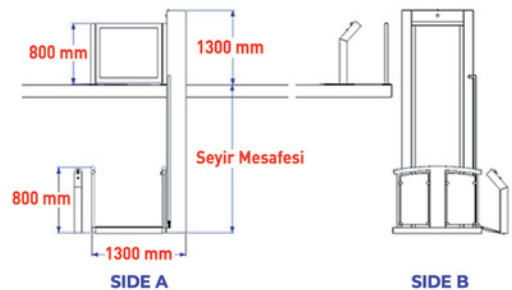
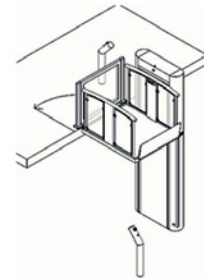
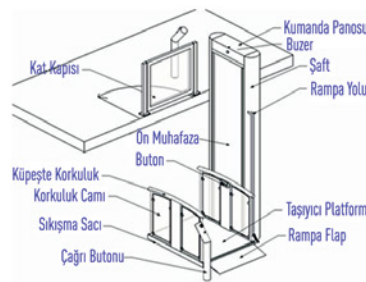
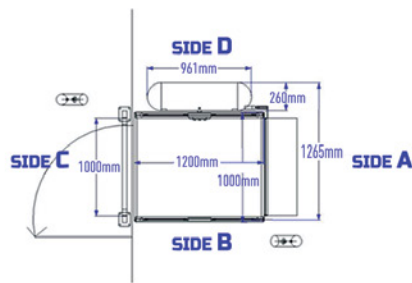

# CORE

## Sonsuz Vida Milli Tahrik Screw Nut System



 Kg 385 Kg Max. Capacity	 Optional bellows	 No machine room	 Emergency rescue Ups / Battery	 Do not require a pit	 940x1250 mm [W x D] Platform size	 1415x1380 mm [W x D] Tower dimension	 Door size full auto 900x1100 mm [WxH]
 0,15m/sn. Max. Speed	 110 / 230 V 50-60 Hz	 Engine 2.2 kW	 Screwed drive type	 3.000 mm Max. Travel	 +50° / -35°	 3 Language Voice Announcements	

Panoramik görünümü, modüler yapısı, kuyusuz dizaynı ve farklı ölçüler de üretilebilen esnek tasarımı ile en küçük alanlara kolayca monte edilir. İç mekan ve dış mekanlarda rahatlıkla kullanabileceğiniz CORE, Vwvf sürüş sistemi ve makine parkurumuzda üretilen güvenli sonsuz vida teknolojisi ile sessiz ve uzun ömürlüdür. Tekerlekli sandalye kullanımına uygun olan Core 7 segment display, aşırı yük, alarm, interkom ve 3 dil anons sistemi ile sunulur. Pusetli küçük çocuklu aileler, hasta yaşlı veya yürüme zorluğu çeken bireyler için platform üzerinde bulunan manüel veya otomatik kapı ve ışın perdesi, ekstra güvenlik sağlar.

With its panoramic view, modular structure, no-hole design and flexible design that can be produced in different sizes, it can be easily installed in the smallest areas. It is quiet and long-lasting with the CORE Vwvf driving system, which you can easily use indoors and outdoors, and the safe endless screw technology produced in our machine park. Suitable for wheelchair use, Core 7 segment display is offered with overload, alarm, intercom and 3-language announcement system.

Manual or automatic door and ray curtain on the platform provide extra security for families with small children with strollers, sick elderly or individuals with walking difficulties.



TS EN 81-41

	For Seat Use			For Wheelchair Use	
	CORE 700	CORE 800	CORE 900	CORE 1000	CORE 1100
<b>SINGLE ENTRY</b>					
Structural Opening	1265x1100 MM	1365x1200 MM	1465x1430 MM	1565x1430 MM	1665x1580 MM
Tower Dimensions	1215x1050 MM	1315x1150 MM	1415x1380 MM	1515x1380 MM	1615x1530 MM
Platform Size	740x920 MM	840x1020 MM	940x1250 MM	1040x1250 MM	1140x1400 MM
Door Opening (WxH)	700x1100 MM	800x1100 MM	900x1100 MM	1000x1100 MM	1100x1100 MM
<b>OPPOSING ENTRY</b>					
Structural Opening	1265x1100 MM	1365x1200 MM	1465x1430 MM	1565x1430 MM	1665x1580 MM
Tower Dimensions	1215x1050 MM	1315x1150 MM	1415x1380 MM	1515x1380 MM	1615x1530 MM
Platform Size	740x920 MM	840x1020 MM	940x1250 MM	1040x1250 MM	1140x1400 MM
Door Opening (WxH)	700x1100 MM	800x1100 MM	900x1100 MM	1000x1100 MM	1100x1100 MM
<b>DIAGONAL ENTRY</b>					
Structural Opening	1340x1100 MM	1440x1200 MM	1540x1430 MM	1640x1430 MM	1740x1580 MM
Tower Dimensions	1290x1050 MM	1390x1150 MM	1490x1380 MM	1590x1380 MM	1690x1530 MM
Platform Size	740x920 MM	840x1020 MM	940x1250 MM	1040x1250 MM	1140x1400 MM
Door Opening (WxH)	700x1100 MM	800x1100 MM	900x1100 MM	1000x1100 MM	1100x1100 MM
<b>GENERAL DIMENSION</b>					
Load Capacity	170 KG	215 KG	290 KG	325 KG	385 KG
Headroom	1500 MM	1500 MM	1500 MM	1500 MM	1500 MM
Pit Height	80 MM	80 MM	80 MM	80 MM	80 MM

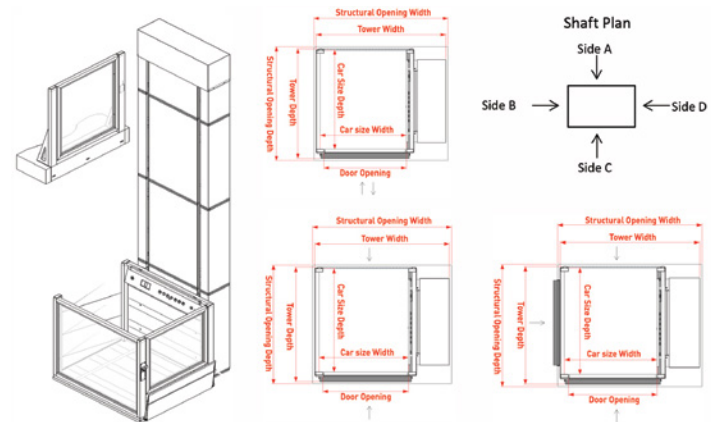

YASAM  
KALİTENİZİ  
ARTIRACAĞAK  
**İNOVATİF  
ADIMLAR...**

INCREASE YOUR LIFE  
QUALITY WITH  
INNOVATIVE STEPS...





**DEVAS**  
home lifts

# MERDİVEN ASANSÖRLERİ STAIRLIFTS

- ▶ DORU
- ▶ ALYA

Gelişmiş Teknoloji ve Yenilikler Bir Arada...

Advanced Technology and Innovations Together...



Fiziksel engel, bizim için  
**asla engel değildir...**

Physical disabilities are  
never an obstacle for us...





## Dönemeçli Merdivenler Curved Stairs

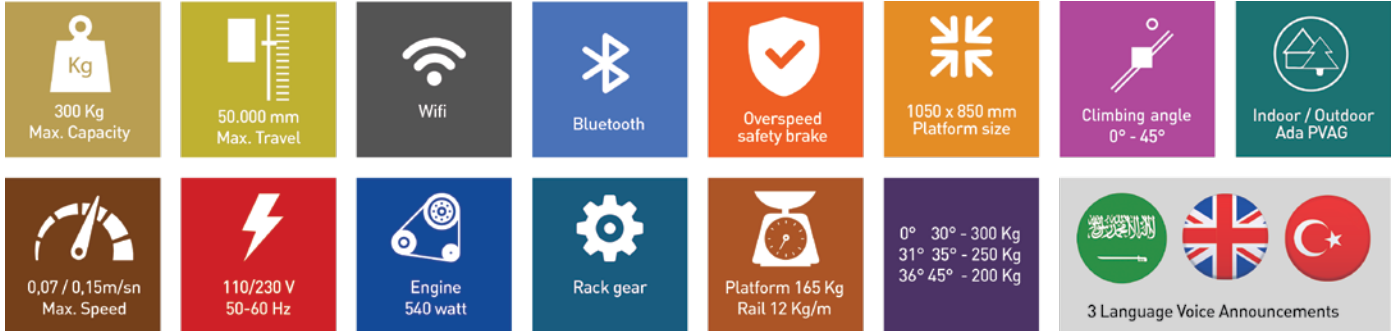



Kavisli merdivenler için geliştirilmiş dönüşlü merdiven asansörü Doru, raylar üzerinde bulunan benzersiz bir bakır bara enerji hattı ile 24 Vdc elektriğini raylar üzerinden alır ve trafiği çok olan uzun seyir mesafeleri için kesintisiz bir hizmet sağlar. Manüel el ile de açılıp kapatılabilen platformun her iki tarafındaki güvenlik bariyerleri ve rampaları asansörün hareketi sırasında kilitlenir ve sadece asansör alt ve üst durak noktalarında iniş ve biniş yapılacağı taraf açılır. Wi-fi bağlantısı ile yazılımları güncellenebilen merdiven asansörlerimiz, Android ve ios uyumlu tablet veya akıllı telefonlar ile tüm ayar ve parametreleri telefon üzerinden kontrol edilebilir.

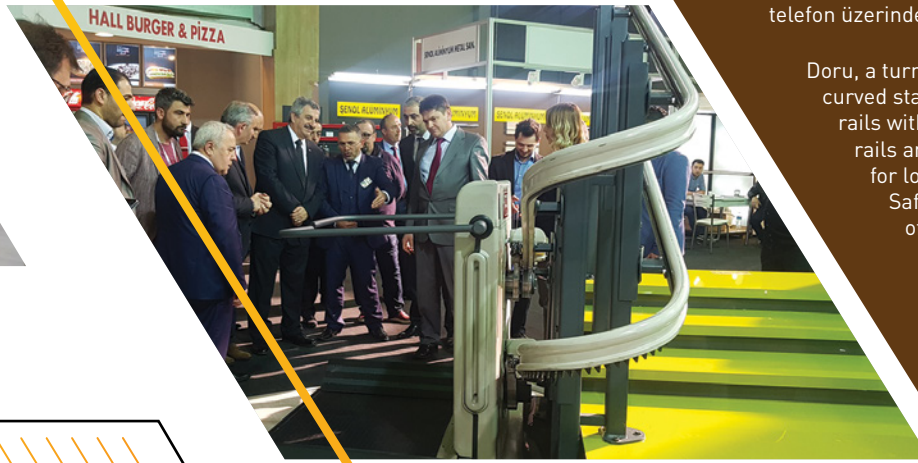

Doru, a turning / curved stairlift developed for curved stairs, receives 24 Vdc electricity from the rails with a unique copper bar power line on the rails and provides an uninterrupted service for long travel distances with heavy traffic. Safety barriers and ramps on both sides of the platform, which can be opened and closed manually, are locked during the movement of the elevator, and only at the lower and upper stops of the elevator, the side where the boarding and landing will take place is opened. Our stairlifts, whose software can be updated via Wi-Fi connection, can be controlled via Android and ios compatible tablets or smart phones, and all settings and parameters can be controlled over the phone.

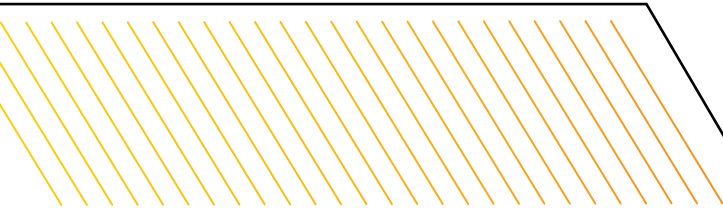



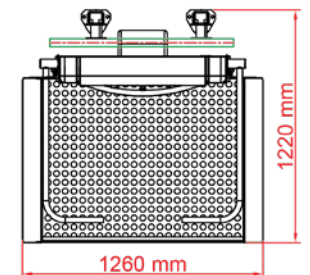
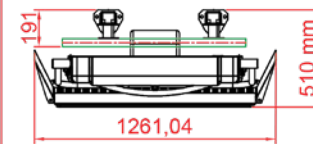
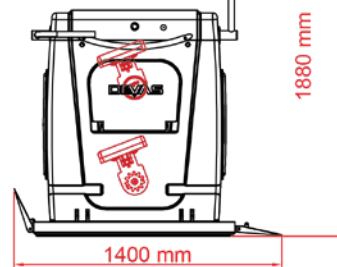
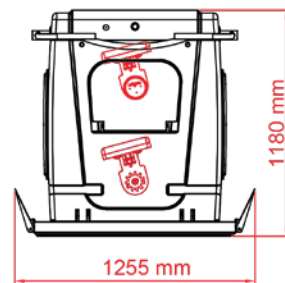
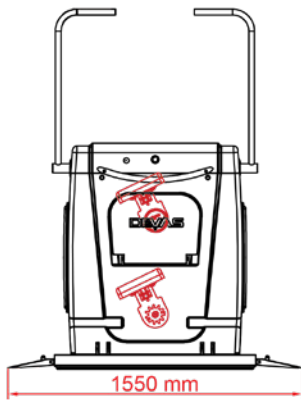









CE  
TS EN 81-40



# ALYA

## Düz Merdivenler Straight Stairs



 300 Kg Max. Capacity	 50.000 mm Max. Travel	 Wifi	 Bluetooth	 Overspeed safety brake	 1050 x 850 mm Platform size	 Climbing angle 0° - 45°	 Indoor / Outdoor Ada PVAG
 0,07 / 0,15m/sn Max. Speed	 110/230 V 50-60 Hz	 Engine 540 watt	 Rack gear	 Platform 165 Kg Rail 12 Kg/m	 0° 30° - 300 Kg 31° 35° - 250 Kg 36° 45° - 200 Kg	   3 Language Voice Announcements	

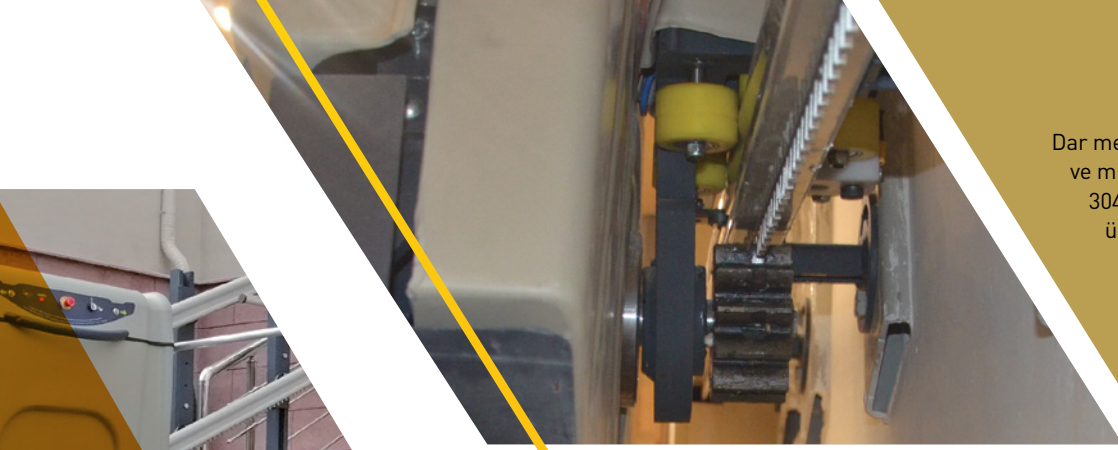

Dar merdiven yapıları için duvar askı aparatları ile duvara monte edilebilir ve minimum yer kaplar. Alüminyumdan imal edilen çift ray teknolojisi, 304 krom gramayer dişlisi ve akrilik kaplaması ile IP55 standartlarında üretilir. 10 metre ve altında çalışan akülü sistemlere kıyasla trafiği yoğun, uzun seyir mesafelerinde çalışabilmesi için enerjisini raylar üzerinden alır ve sizi asla yolda bırakmaz. Alt ve üst durak noktalarında bulunan ergonomik uzaktan kumandaları veya akıllı telefonlar üzerinden kontrol edilebilen katlanabilir merdiven asansörlerimiz, aşırı yük, aşırı hız, VSR akıllı ses asistanı ile birçok dil seçeneği ile tüm hareketlerini ve oluşan hataları sesli anons eder.

It can be mounted on the wall with wall hangers for narrow staircase structures and takes up minimal space. It is produced according to IP55 standards with double rail technology made of aluminum, 304 chrome grammar gear and acrylic coating Compared to battery-operated systems operating at 10 meters or less, it takes its energy from the rails so that it can operate at long cruising distances with heavy traffic and never leaves you on the road. Our foldable stairlifts, which can be controlled via ergonomic remote controls or smart phones at the lower and upper stops, Overload, overspeed, VSR smart voice assistant and many language options, it announces all movements and errors that occur.

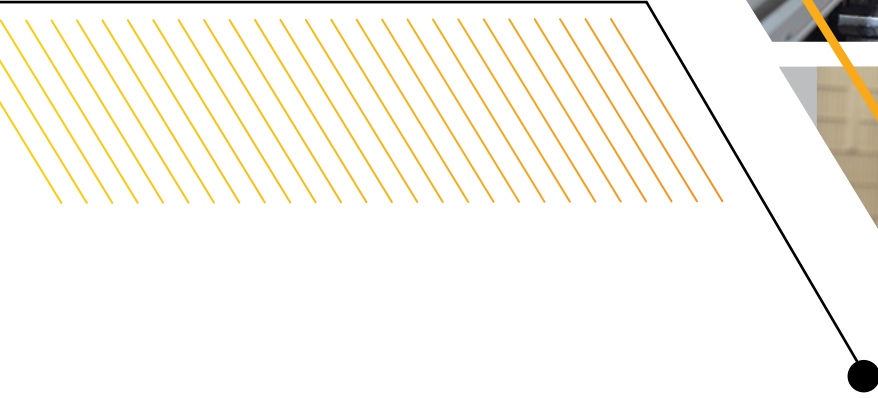

CE  
TS EN 81-40

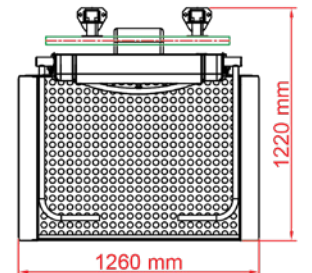
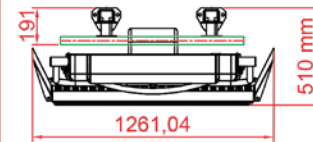
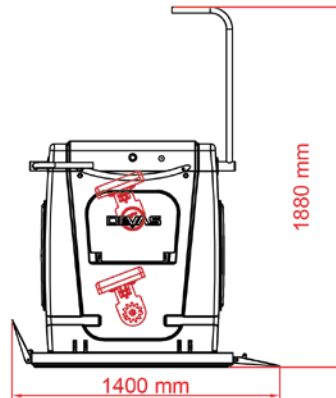
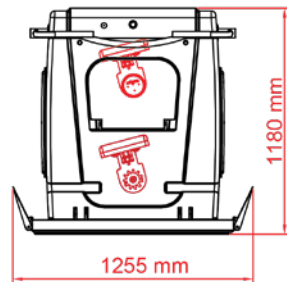
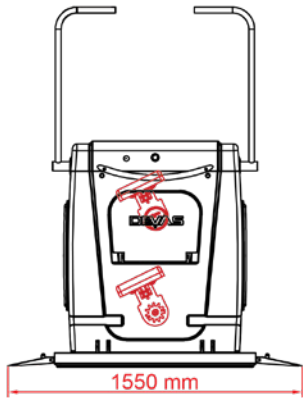

# KOLTUK ASANSÖRÜ

Modern Tasarım  
Freecurve Stairlift



 Indoor / Outdoor	 110 / 230 V 50-60 Hz	 Max. Travel 28.000 mm	 Climbing angle 0° - 70°
 115/200 Kg Max. Capacity	 0,15m/sn. Max. Speed	 Engine 2x350 Watt	 Battery 24 V

## Alliance Seat



Güvenliğinizden ödün vermeden uygun bir koltuklu dönümlü merdiven asansörü çözümü arıyorsanız tam size göre. Eklem rahatsızlığı olan, merdiven inme ve çıkma gibi aktivitelerde zorlanan kişiler için kullanımı kolaydır. Düz ve dönümlü merdivenler için tasarlanan merdiven asansörü, her türlü ölçü ve konforu ile sizi istediğiniz kata taşır.

Designed for flat ladder, it has all the necessary dimensions for people who have difficulty in activities such as stairlift uphill and stair climbing.



Smart seat	Dimensions
A Minimum swivel radius - With armrest spacers - With extended armrest spacers	670mm 695mm 710mm
B Wall to inner seat back*	75mm
C Seat depth - With extended seat	360mm 425mm
D Minimum folded width to footplate*	385mm
E Minimum open width to edge footplate*	650mm
F Armrest width – external - With armrest spacers - With extended armrest spacers	550mm 590mm 635mm
G Armrest width – internal - With armrest spacers - With extended armrest spacers	460mm 515mm 560mm
H Seat back height	455mm
I Footplate to seat height - Standard seat option - Perch seat option**	465-540mm 675-875mm
J Minimum footplate height	85mm
Minimum track intrusion into staircase	115mm
Maximum weight limit - Standard version - Heavy duty version (XL)*** - Extra heavy duty version (XXL)***	137kg 160kg 200kg

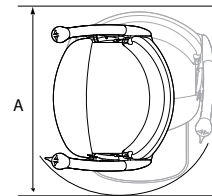
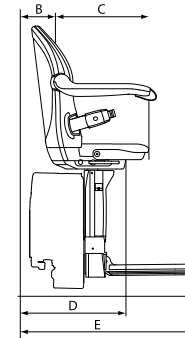
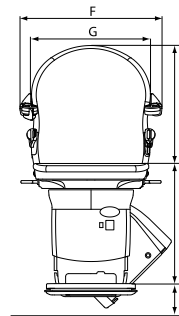

CE  
EN 81-40





HAYATINIZI  
KOLAYLAŐTIRMAK  
İÇİN

**HİÇBİR ENGEL  
YOK...**

NO OBSTACLES TO  
MAKE YOUR LIFE  
EASIER.

**DEVAS**  
*home lifts*

# HOMELIFT

- ▶ GL 400
- ▶ TUBELIFT
- ▶ OCTALIFT

Yeni nesil asansör sistemleri...

New generation elevator systems.....

Hayatın her yerinde  
**güven ve konfor...**

Safety and comfort  
for your life...

# GL-400

Hayatınızı kolaylaştırır.

It makes your life easier.

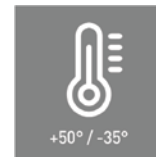
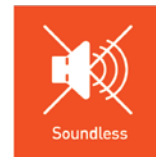
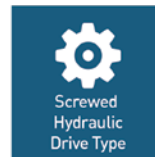
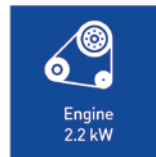
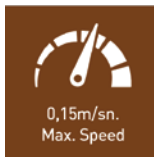
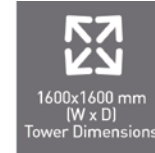

Merdiven çıkmakta zorlanıyor ve evinizde nasıl kalabileceğinizi mi düşünüyorsunuz? Günleriniz çocuklarla ve alışveriş çantalarıyla dolu ellerinizle merdivenlerden inip çıkmak ile mi geçiyor? Yoksa sadece daha fazla konfor ve rahatlık mı arıyorsunuz? Farklı erişilebilirlik, konfor ve alan gereksinimleri için oluşturulmuş bir dizi ev asansörümüz var. Hepsi size iyi düşünülmüş bir ergonomi sunar ve her zaman için rahat etmesi için Akıllı Güvenlik sistemlerimizle donatılmıştır. DEVAS, eviniz için altı farklı ölçüde ev asansörü üretmektedir: 1100 mm' den 1600 mm'e kadar DEVAS HOMELİFT GL-400 modellerimize göz atın ve hangi modelin ve hangi ölçünün ihtiyaçlarınıza en uygun olduğunu öğrenin!

Having trouble climbing stairs and wondering how to stay at home? Do you spend your days walking up and down stairs with kids and hands full of shopping bags? Or are you just looking for more comfort and convenience? We have a range of home lifts created for different accessibility, comfort and space requirements. All offer well thought-out ergonomics and are equipped with our Smart Safety systems for your peace of mind at all times. DEVAS manufactures six different sizes of home elevators for your home: Take a look at our DEVAS HOMELIFT GL-400 Models from 1100 mm to 1600 mm and find out which model and which size best suits your needs!

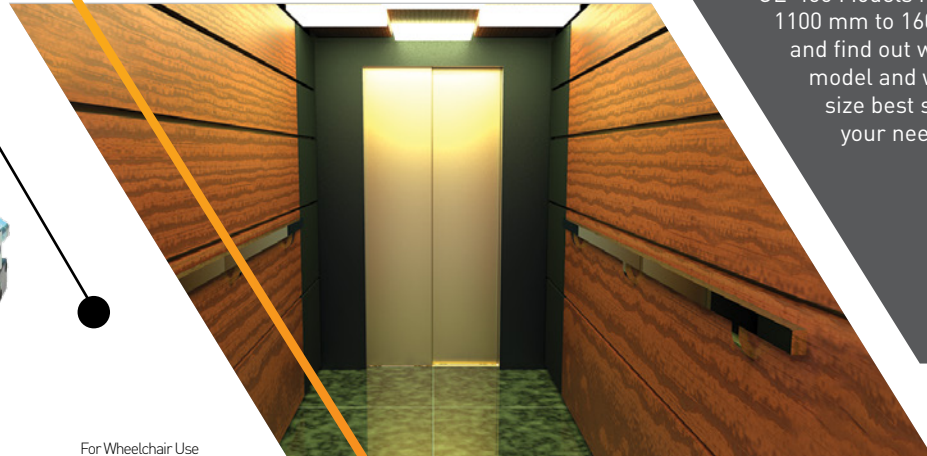

For Seat Use

For Wheelchair Use

	GL 1100	GL 1200	GL 1300	GL 1400	GL 1500	GL 1600
<b>SINGLE ENTRY</b>						
Structural Opening	1150x1150 MM	1250x1250 MM	1350x1350 MM	1450x1450 MM	1550x1550 MM	1650x1650 MM
Tower Dimensions	1100x1100 MM	1200x1200 MM	1300x1300 MM	1400x1400 MM	1500x1500 MM	1600x1600 MM
Cabin Size (DxW)	600x850 MM	700x950 MM	800x1050 MM	900x1150 MM	1000x1250 MM	1100x1350 MM
Door Opening (WxH)	600x2000 MM	700x2000 MM	800x2000 MM	900x2000 MM	900x2000 MM	900x2000 MM
<b>OPPOSING ENTRY</b>						
Structural Opening	1150x1150 MM	1250x1250 MM	1350x1350 MM	1450x1450 MM	1550x1550 MM	1650x1650 MM
Tower Dimensions	1100x1100 MM	1200x1200 MM	1300x1300 MM	1400x1400 MM	1500x1500 MM	1600x1600 MM
Cabin Size (DxW)	600x850 MM	700x950 MM	800x1050 MM	900x1150 MM	1000x1250 MM	1100x1350 MM
Door Opening (WxH)	400x2000 MM	500x2000 MM	600x2000 MM	700x2000 MM	800x2000 MM	900x2000 MM
<b>DIAGONAL ENTRY</b>						
Structural Opening	1150x1150 MM	1250x1250 MM	1350x1350 MM	1450x1450 MM	1550x1550 MM	1650x1650 MM
Tower Dimensions	1100x1100 MM	1200x1200 MM	1300x1300 MM	1400x1400 MM	1500x1500 MM	1600x1600 MM
Cabin Size (DxW)	600x900 MM	700x1000 MM	800x1100 MM	900x1200 MM	1000x1250 MM	1100x1350 MM
Door Opening (WxH)	400-600x2000 MM	500-700x2000 MM	600-800x2000 MM	700-900x2000 MM	800-900x2000 MM	900x2000 MM
<b>GENERAL DIMENSION</b>						
Load Capacity	125 KG	160 KG	250 KG	315 KG	385 KG	400 KG
Headroom	2350 MM	2350 MM	2350 MM	2350 MM	2350 MM	2350 MM
Pit Height	250 MM	250 MM	250 MM	250 MM	250 MM	250 MM

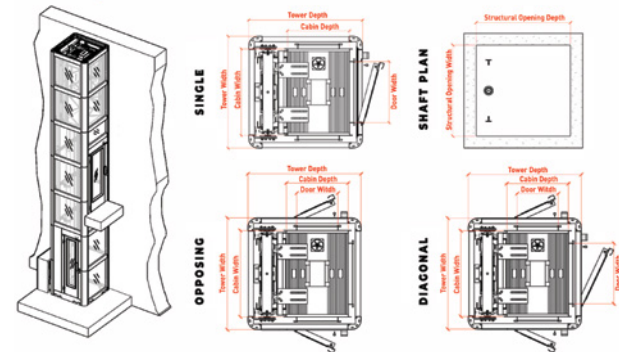

TS EN 81-41

# Tubelift

Işığınız hiç kesilmesin...

Your light  
never be cut off...

 400 Kg Max. Capacity	 Maksimum Number of steps 7	 No machine room	 Emergency rescue Ups / Battery	 Do not require a pit	 650x2100 mm Cabin diameter	 900 mm Tower diameter	 Door Size 500x2100 mm (WxH)
 0,15m/sn. Max. Speed	 110 / 230 V 50-60 Hz 1/3 Phase	 Engine 2.2 kW	 Drum motor drive	 28.000 mm Max. Travel	 Overspeed safety brake	 3 Language Voice Announcements	

Farklı boyutlarda, taşıma kapasitelerinde ve renk kombinasyonlarında ev tipi asansörler sunuyoruz. Muhtemelen evinizdeki en ikonik parçalardan biri olacak olan TUBELIFT dekorasyonunuza uyum sağlar. Şeffaf yapısı sayesinde size manzaranın keyfini çıkarmak kalır. Göz alıcı ama göze batmayan ev asansörü çözümlerimizden TUBELIFT, dekoratif krom kaplama, polyester boya, MDF veya antibakteriyel pvc taban gibi özelleştirilebilir seçenekler ve bir çok aksesuar sunar. Yaşam alanınızın ortasına veya pencerelerin yanına monte edilsin gün ışığınız asla kesilmez. Geleneksel asansörlerin uygulanamadığı alanlarınıza, benzersiz bir sürüş sistemi ile gece gündüz konfor ve güven içerisinde kullanabilirsiniz.

We offer home elevators in different sizes, carrying capacities and color combinations.

TUBELIFT, which will probably be one of the most iconic pieces in your home, adapts to your decoration. With the transparent structure, all you have to do is enjoying the view.

TUBELIFT, one of our eye-catching but unobtrusive home elevator solutions, offers customizable options such as decorative chrome plating, polyester paint, MDF or antibacterial PVC base, and many accessories.

Whether installed in the middle of your living space or near windows, your daylight will never be interrupted.

You can use it in your areas where traditional elevators cannot be applied, with a unique driving system, day and night, in comfort and confidence.

CE  
TS EN 81-41



For Seat Use

For Wheelchair Use

	TUBE 900	TUBE 1100	TUBE 1300	TUBE 1500	TUBE 1700
<b>SINGLE ENTRY</b>					
Structural Opening	950 MM	1150 MM	1350 MM	1550 MM	1750 MM
Tower Diameter	900 MM	1100 MM	1300 MM	1500 MM	1700 MM
Cabin Diameter (Ø)	650x2100 MM	850x2100 MM	1050x2100 MM	1250x2100 MM	1450x2100 MM
Door Opening	500x2100 MM	500x2100 MM	650x2100 MM	800x2100 MM	950x2100 MM
<b>OPPOSING ENTRY</b>					
Structural Opening	950 MM	1150 MM	1350 MM	1550 MM	1750 MM
Tower Diameter	900 MM	1100 MM	1300 MM	1500 MM	1700 MM
Cabin Diameter (Ø)	650x2100 MM	850x2100 MM	1050x2100 MM	1250x2100 MM	1450x2100 MM
Door Opening	500x2100 MM	500x2100 MM	650x2100 MM	800x2100 MM	950x2100 MM
<b>DIAGONAL ENTRY</b>					
Structural Opening		1100 MM	1350 MM	1550 MM	1750 MM
Tower Diameter		1100 MM	1300 MM	1500 MM	1700 MM
Cabin Diameter (Ø)	NOT APPLICABLE	850x2100 MM	1050x2100 MM	1250x2100 MM	1450x2100 MM
Door Opening		500x2100 MM	650x2100 MM	800x2100 MM	950x2100 MM
<b>GENERAL DIMENSION</b>					
Load Capacity	80 KG	160 KG	250 KG	325 KG	400 KG
Headroom	2900 MM	2900 MM	2900 MM	2900 MM	2900 MM
Pit Height	100 MM	100 MM	100 MM	100 MM	100 MM

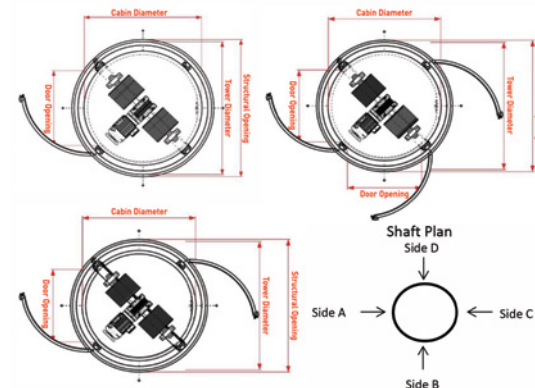

# OCTOLIFT

Görüşünüzü engellemez.

Your view  
will never blocked.

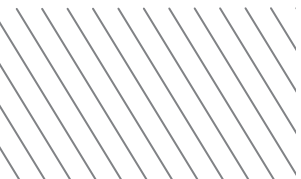

 400 Kg Max. Capacity	 Maksimum Number of stops 7	 No machine room	 Emergency rescue Ups / Battery	 Do not require a pit	 950x950x2100 mm (W x D) Cabin size	 1200x1200 mm (W x D) Tower outer size	 Door Size 790x2100 mm (WxH)
 0,15m/sn. Max. Speed	 110 / 230 V 50-60 Hz 1/3 Phase	 Engine 2.2 kW	 Drumm motor drive	 28.000 mm Max. Travel	 Overspeed safety brake	 3 Language Voice Announcements	



Büyük inşaat işleri gereksinimi olmaksızın, yeni ve mevcut binalara entegre edilmesi kolay, her şey dahil bir asansör konseptidir. Ayrıca zamansız tasarımı, geniş renk ve malzeme seçeneklerimiz sayesinde çoğu mimari stilde kusursuz bir şekilde uyum sağlar. Beş farklı standart ölçü ve sonsuz renk seçeneği ile imal edilebildiği gibi, mimari yapınıza uyacak şekilde farklı ölçü ve kaplama seçenekleri ile de üretilebilir. Sekizgen yapısı, manüel veya otomatik kapıları ve tekerlekli sandalye ile de kullanabileceğiniz OCTALIFT kompakt tasarımı ile en küçük asansör modelidir.

without the need for major construction works, easy to integrate into new and existing buildings, It is an all-inclusive elevator concept. Plus, its timeless design blends seamlessly with most architectural styles, thanks to our wide selection of colors and materials. It can be manufactured with five different standard sizes and endless color options, as well as with different size and coating options to suit your architectural structure. OCTALIFT is the smallest elevator model with its octagonal structure, manual or automatic doors and compact design that you can use with a wheelchair.

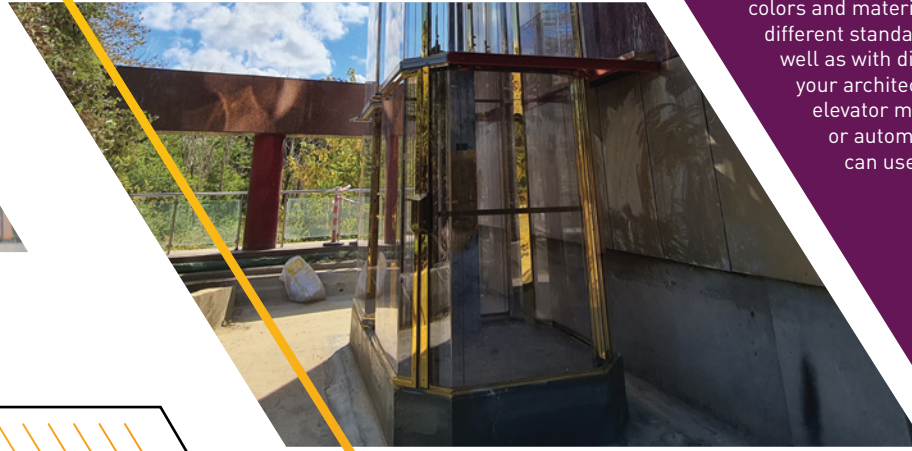

CE  
TS EN 81-41



For Seat Use

For Wheelchair Use

	OCTA 800	OCTA 1000	OCTA 1200	OCTA 1400	OCTA 1600
<b>SINGLE ENTRY</b>					
Structural Opening	850x850 MM	1050x1050 MM	1250x1250 MM	1450x1450 MM	1250x1250 MM
Tower Outer Size	800x800 MM	1000x1000 MM	1200x1200 MM	1400x1400 MM	1200x1200 MM
Cabin Size	550x550x2100 MM	750x750x2100 MM	950x950x2100 MM	1150x1150x2100 MM	1350x1350x2100 MM
Door Opening Size	420x2100 MM	620x2100 MM	790x2100 MM	930x2100 MM	1050x2100 MM
<b>OPPOSING ENTRY</b>					
Structural Opening	850x850 MM	1050x1050 MM	1250x1250 MM	1450x1450 MM	1250x1250 MM
Tower Outer Size	800x800 MM	1000x1000 MM	1200x1200 MM	1400x1400 MM	1200x1200 MM
Cabin Size	550x550x2100 MM	750x750x2100 MM	950x950x2100 MM	1150x1150x2100 MM	1350x1350x2100 MM
Door Opening Size	420x2100 MM	620x2100 MM	790x2100 MM	930x2100 MM	1050x2100 MM
<b>DIAGONAL ENTRY</b>					
Structural Opening	850x850 MM	1050x1050 MM	1250x1250 MM	1450x1450 MM	1250x1250 MM
Tower Outer Size	800x800 MM	1000x1000 MM	1200x1200 MM	1400x1400 MM	1200x1200 MM
Cabin Size	550x550x2100 MM	750x750x2100 MM	950x950x2100 MM	1150x1150x2100 MM	1350x1350x2100 MM
Door Opening Size	420x2100 MM	620x2100 MM	790x2100 MM	930x2100 MM	1050x2100 MM
<b>GENERAL DIMENSION</b>					
Load Capacity	80 KG	160 KG	250 KG	325 KG	400 KG
Headroom	2900 MM	2900 MM	2900 MM	2900 MM	2900 MM
Pit Height	100 MM	100 MM	100 MM	100 MM	100 MM

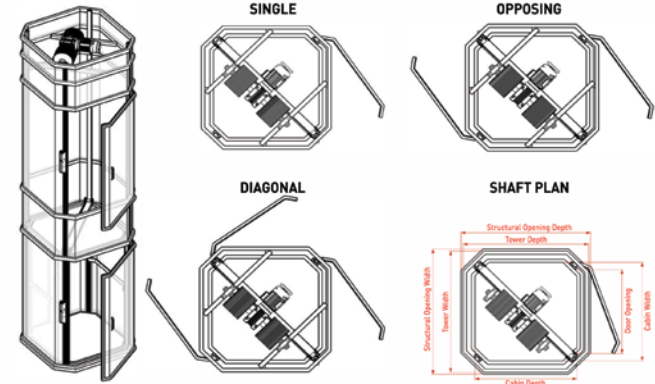

# YEMEK ASANSÖRÜ

## DUMBWAITER



İşinizi **kolaylaştırıyoruz...**  
We make your work easier...





İnvertör sistemi ile hassas seviyeleme ve duruş.



 150 Kg Max. Capacity	 Maksimum Number of stops 6	 No machine room	 Emergency rescue Ups / Battery	 Do not require a pit	 1000x1000 mm (W x D) Car internal measurement	 1230x1130 mm (W x D) Tower outer size	 Cabin size 1000 X 1000 mm (WxH)
 0,30 m/sn. Max. Speed	 110 / 230 V 50-60 Hz 1/3 Phase	 Engine 0,55 kW	 With Counterweight	 +50° / -35°	 Soundless	 3 Language Voice Announcements	

Genellikle restoranlarda, otellerde, hastanelerde, kütüphanelerde, sanayi tesislerinde, ofis binalarında, villalarda ve çok katlı yemekhanesi olan büyük mutfaklarda kullanılabileceğiniz Garsoon yemek asansörü invertörlü ve karşı ağırlık sistemi sayesinde yemekleriniz dökülmeden katlar arası taşımanızı sağlayacak en küçük boylu en büyük yardımcınız. İstenildiğinde kabinin içerisine tabak, bardak dosya ve küçük eşyalar konulacak raflar, gıda standartlarına uygun hijyenik materyallerden imal edilmektedir.

Garsoon food elevator, which can be used in restaurants, hotels, hospitals, libraries, industrial facilities, office buildings, villas and large kitchens with multi-storey dining halls, is the smallest and biggest assistant that will enable you to carry your food between floors without spilling, thanks to its inverter and counterweight system.

Shelves where plates, glasses, folders and small items can be placed in the cabinet when requested, its manufactured from hygienic materials in accordance with food standards.

**Technical Compliance**  
European Machinery Directive 2006/42/EC  
European Standard EN 81-3

SINGLE ENTRY	GRS 400	GRS 500	GRS 600	GRS 800	GRS 1000	
Structural Opening	650x550 MM	750x650 MM	850x750 MM	1050x950 MM	1250x1150 MM	
Tower Outer Size	630x530 MM	730x630 MM	830x730 MM	1030x930 MM	1230x1130 MM	
Cabin Size	400x400 MM	500x500 MM	600x600 MM	800x800 MM	1000x1000 MM	
Door Opening Size	400x600 MM	500x800 MM	600x800 MM	800x800 MM	1000x1000 MM	
OPPOSING ENTRY	Structural Opening	650x550 MM	750x650 MM	850x750 MM	1050x950 MM	1250x1150 MM
Tower Outer Size	630x530 MM	730x630 MM	830x730 MM	1030x930 MM	1230x1130 MM	
Cabin Size	400x400 MM	500x500 MM	600x600 MM	800x800 MM	1000x1000 MM	
Door Opening Size	400x600 MM	500x800 MM	600x800 MM	800x800 MM	1000x1000 MM	
DIAGONAL ENTRY	Structural Opening	650x650 MM	750x750 MM	850x850 MM	1050x1050 MM	1250x1250 MM
Tower Outer Size	630x630 MM	730x730 MM	830x830 MM	1030x1030 MM	1230x1230 MM	
Cabin Size	400x500 MM	500x600 MM	600x700 MM	800x900 MM	1000x1100 MM	
Door Opening Size	400x600 MM	500x800 MM	600x800 MM	800x800 MM	1000x1000 MM	
GENERAL DIMENSION	Load Capacity	50 KG	50 KG	100 KG	150 KG	150 KG
Headroom	2400 MM	2600 MM	2600 MM	2700 MM	2800 MM	
Pit Height	900 MM	900 MM	900 MM	900 MM	900 MM	

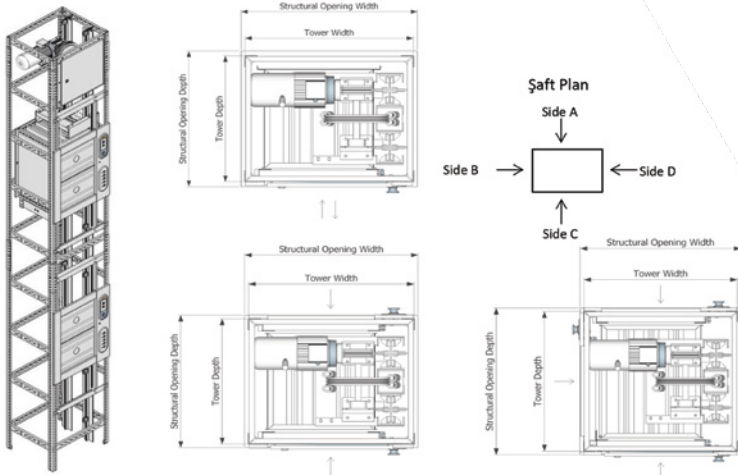

A 3D rendered logo for 'DEVAS' is positioned on a dark, reflective floor. The letters are blue with silver outlines and shadows. The 'V' and 'S' have orange accents. The 'A' and 'S' feature a cursive script underneath. A thick blue diagonal stripe runs from the top right towards the bottom left. In the background, a curved metal railing is visible against a dark wall.

DEVAS

YAŞAM KALİTENİZ İÇİN  
**KURUMSAL  
ÇÖZÜMLER**

CORPORATE SOLUTIONS  
FOR YOUR LIFE QUALITY





# Mimari Projelerinizde **özüm ortađınız**

Your Solution Partner in  
Architectural Projects



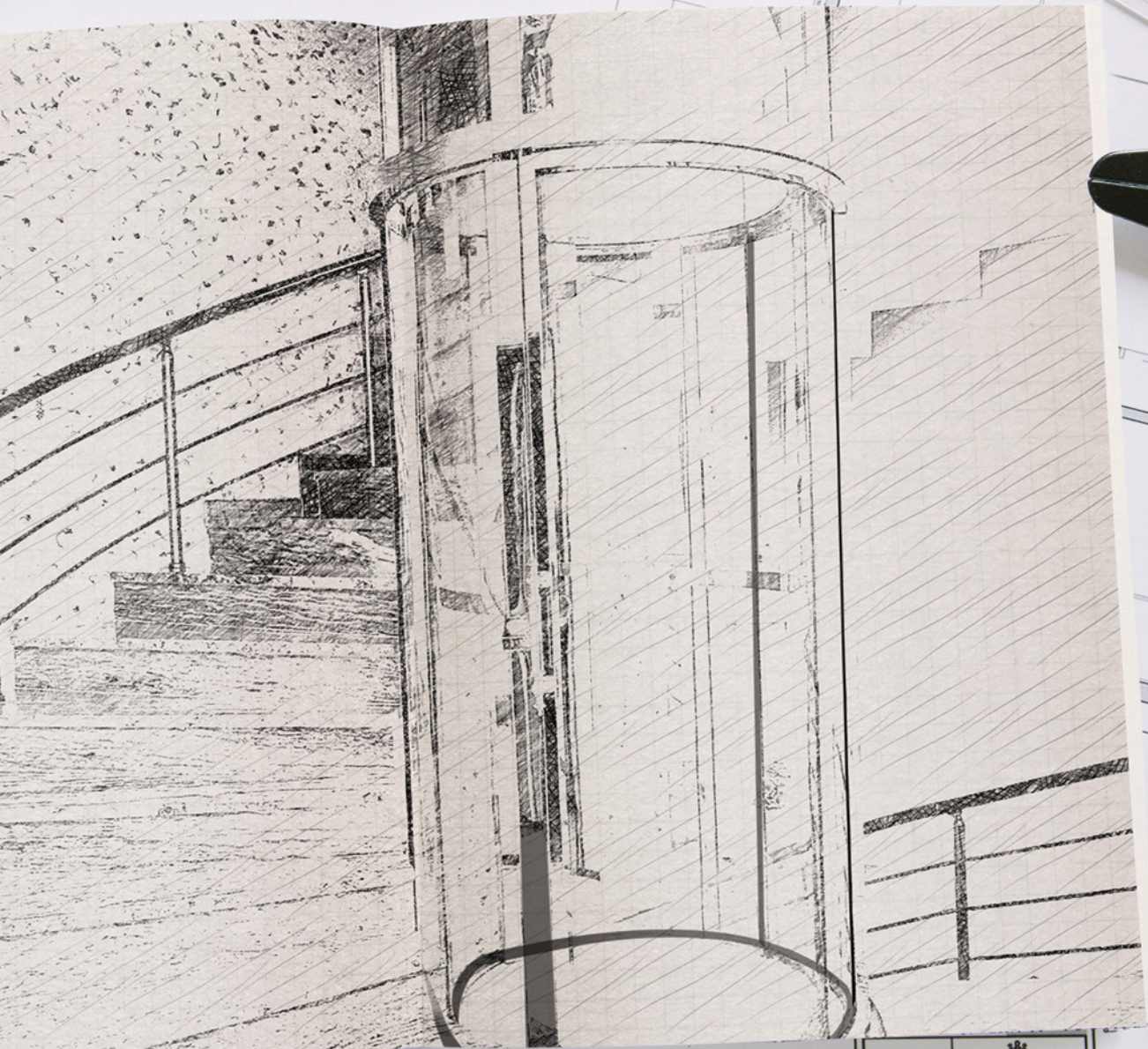
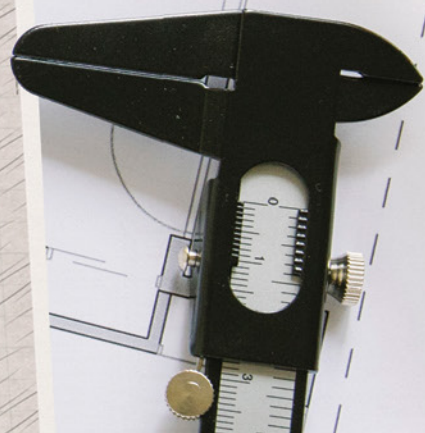
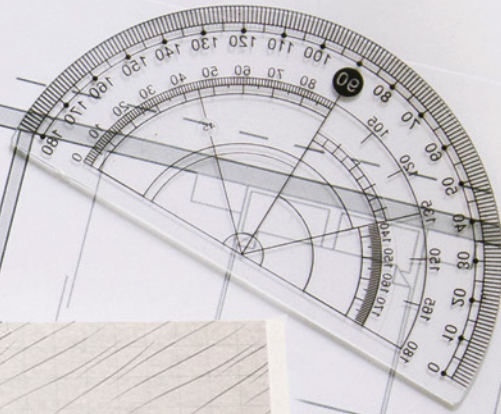
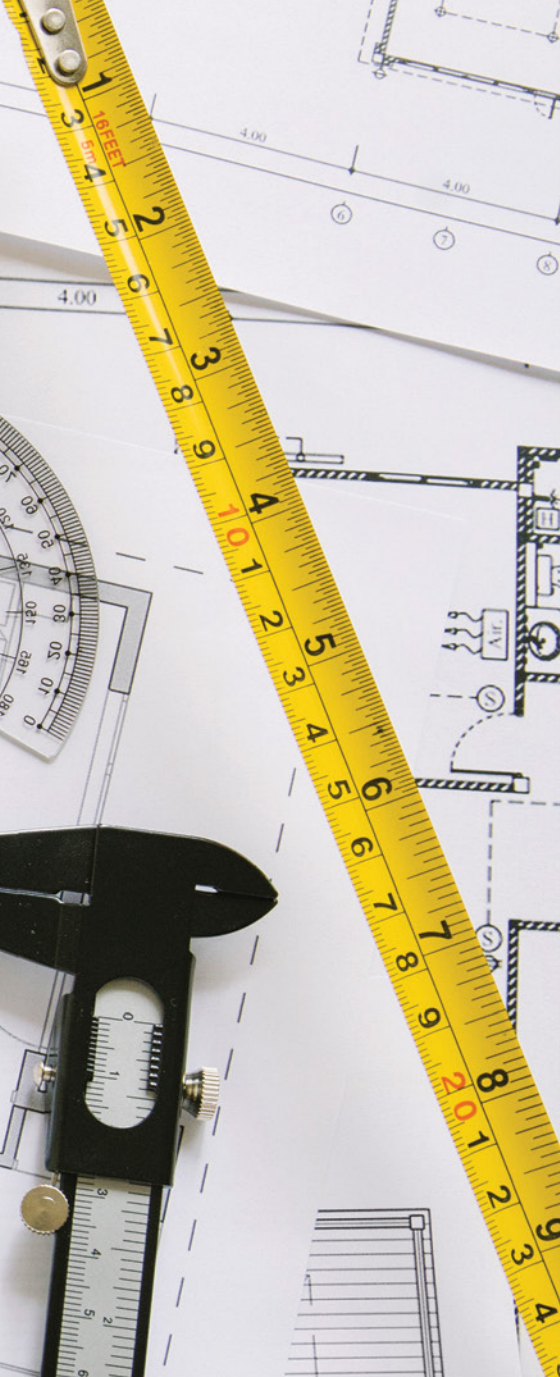
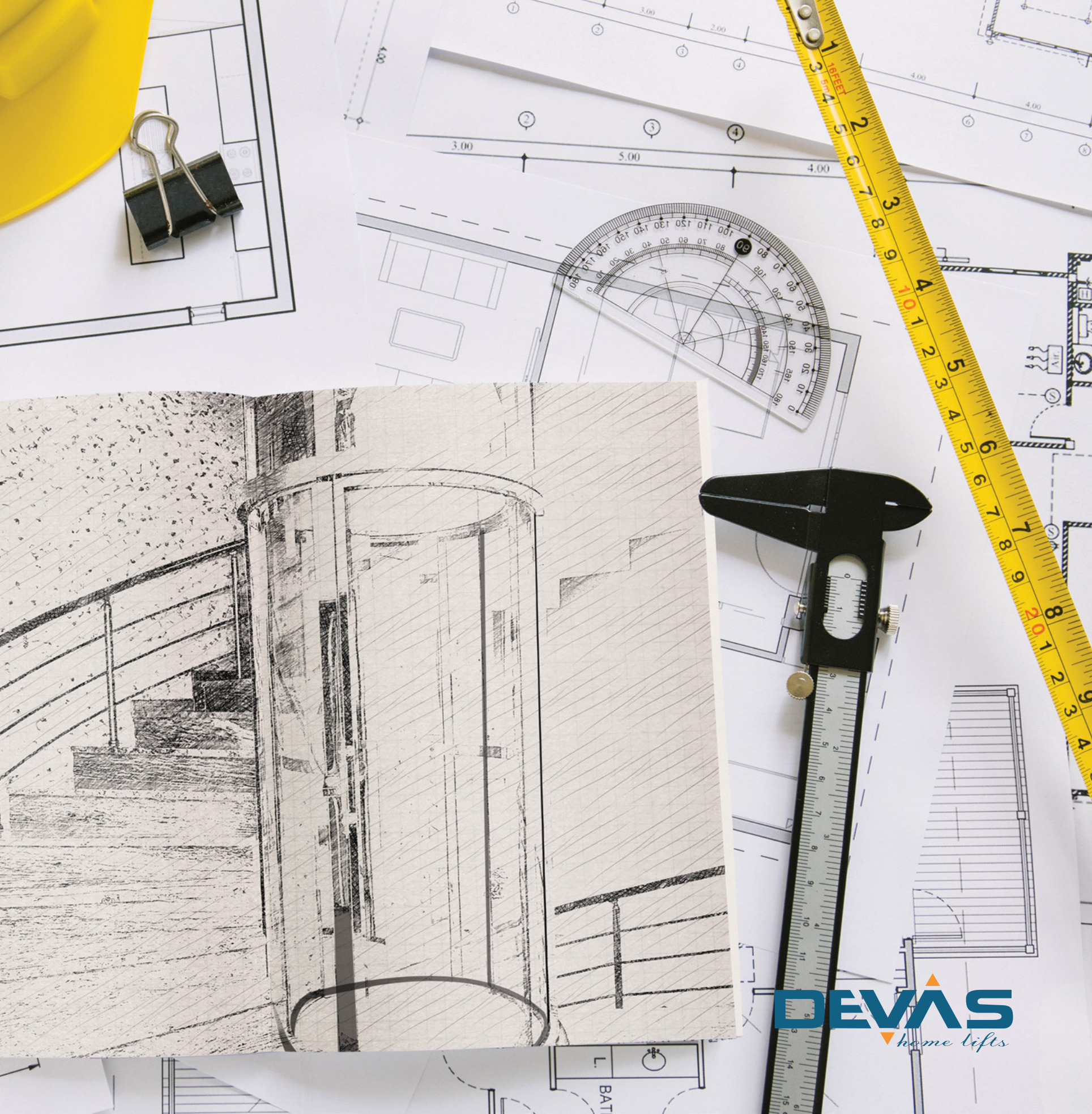

**DEVAS**  
home lifts

BATT  
L

**BİLGİ VE DESTEK İÇİN**

**Contact Us**

Mimarsinan Organize Sanayi Bölgesi  
23. Cd. No:74 38165 Melikgazi | Kayseri | TÜRKİYE  
satis@devas.com.tr  
export@devas.com.tr  
WhatsApp : +90 533 655 45 13

**Ürünlerimiz 2 yıl garantilidir.**

Our products has 2 years warranty.



**DEVAS**  
*home lifts*



 DEVAS FACTORY